



**INSTRUCTIONS D'ASSEMBLAGE**  
**ASSEMBLY INSTRUCTIONS**

---

**M**ONARCH  
SPECIALTIES INC.

# I 2415

---

**TABLE D'APPOINT -**  
**47" L / CONSOLE D'ENTREE ESPRESSO**

**ACCENT TABLE -**  
**47" L / ESPRESSO HALL CONSOLE**



**POUR DE L'ASSISTANCE OU POUR COMMANDER  
DES PIÈCES CONTACTEZ NOTRE DÉPARTEMENT  
DE SERVICE À LA CLIENTÈLE.**

**FOR ASSISTANCE OR TO ORDER PARTS  
CONTACT OUR CUSTOMER SERVICE DEPARTMENT**

**WWW.MONARCHSERVICE.COM**

**LISTE DES PIÈCES**  
**PARTS LIST**

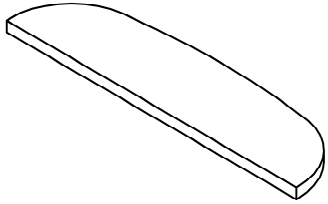
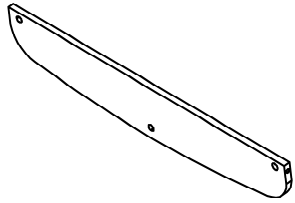
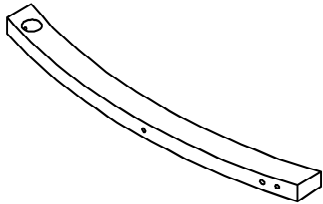
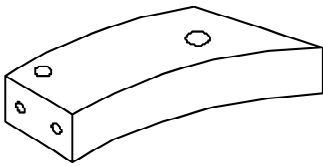
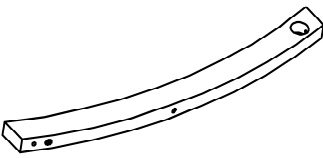
PIÈCE / PART #	IMAGE	DESCRIPTION	QTY / QTÉ
1		TABLE TOP SURFACE DE TABLE	1
2		SHELF ÉTAGÈRE	1
3		SUPPORT LEG PATTE DE SOUTIEN	1
4		BRACE ATTACHE	1
5		FRONT FACING LEFT LEG PATTE AVANT GAUCHE	1

**LISTE DES PIÈCES**  
**PARTS LIST**

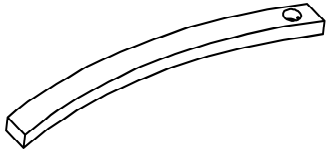
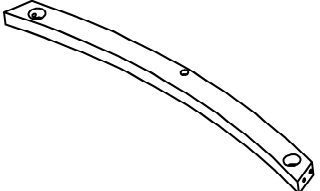
PIÈCE / PART #	IMAGE	DESCRIPTION	QTY / QTÉ
6		<p>FRONT FACING RIGHT LEG PATTE AVANT DROITE</p>	1
7		<p>CROSSBAR BARRE TRANSVERSALE</p>	1

**LISTE DES PIÈCES DE MONTAGE**  
**HARDWARE LIST**

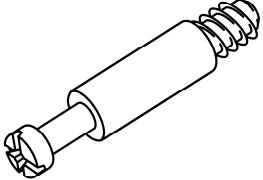
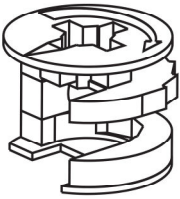
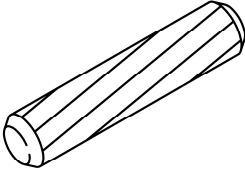
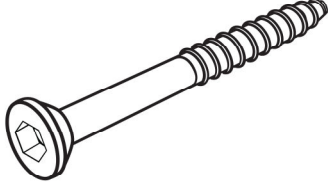
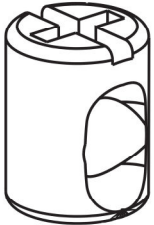
PIÈCE / PART #	IMAGE	DESCRIPTION	QTY / QTÉ
A		CAM LOCK SCREW - 1 1/8" VIS CAM LOCK - 1 1/8"	4
B		CAM LOCK CONNECTOR - Ø5/8" ÉCROU CAM LOCK - Ø5/8"	4
C		WOOD DOWEL - Ø3/8" X 1" GOUJON DE BOIS - Ø3/8" X 1"	7
D		ASSEMBLING SCREW - Ø1/4" X 2 5/8" VIS D'ASSEMBLAGE - Ø1/4" X 2 5/8"	1
E		BARREL NUT - Ø3/8" X 5/8" ÉCROU DE CANON - Ø3/8" X 5/8"	1

**LISTE DES PIÈCES DE MONTAGE**  
**HARDWARE LIST**

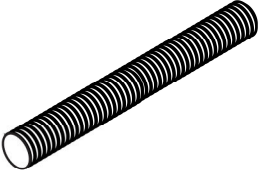
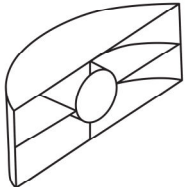
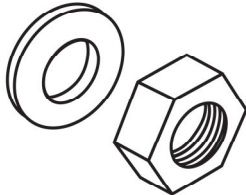
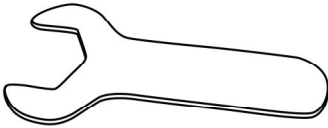
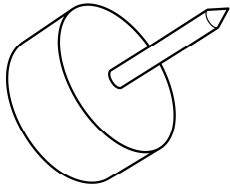
PIÈCE / PART #	IMAGE	DESCRIPTION	QTY / QTÉ
F		<p>THREADED ROD - Ø3/8" X 2 3/4"</p> <p>TIGE FILETÉE - Ø3/8" X 2 3/4"</p>	5
G		<p>NUT</p> <p>ÉCROU</p>	5
H		<p>NUT SET</p> <p>ENSEMBLE D'ÉCROU</p>	5
I		<p>SPANNER</p> <p>CLÉ ANGLAISE</p>	1
J		<p>FLOOR PROTECTOR - Ø5/8"</p> <p>PROTECTEUR DE PLANCHER - Ø5/8"</p>	3

**LISTE DES PIÈCES DE MONTAGE**  
**HARDWARE LIST**

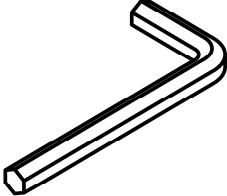
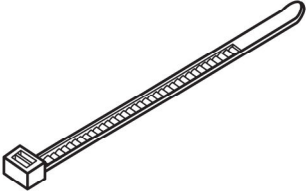
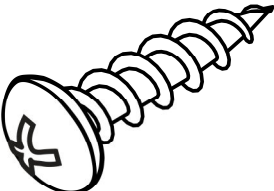
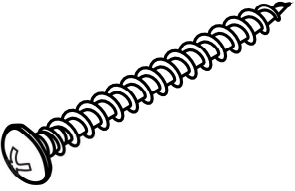
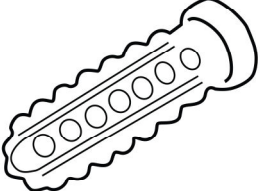
PIÈCE / PART #	IMAGE	DESCRIPTION	QTY / QTÉ
K		HEX KEY CLÉ HEXAGONALE	1
L		ZIP TIE - 7 3/4" X 1/8" ATTACHE AUTOBLOQUANTE - 7 3/4" X 1/8"	1
M		ASSEMBLING SCREW - Ø1/8" X 1" VIS D'ASSEMBLAGE - Ø1/8" X 1"	1
N		ASSEMBLING SCREW - Ø1/4" X 1 1/2" VIS D'ASSEMBLAGE - Ø1/4" X 1 1/2"	1
O		ANCHOR - Ø3/8" X 1 1/2" ANCRE - Ø3/8" X 1 1/2"	1

**LISTE DES PIÈCES DE MONTAGE**  
**HARDWARE LIST**

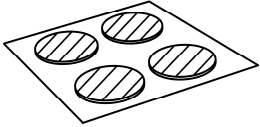
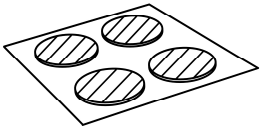
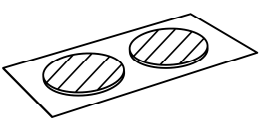
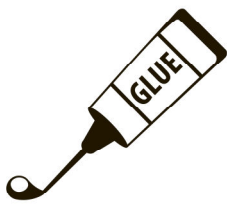
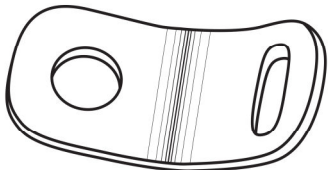
PIÈCE / PART #	IMAGE	DESCRIPTION	QTY / QTÉ
P		FINISHING STICKER - Ø1 3/4" COLLANT DE FINITION - Ø1 3/4"	5
Q		FINISHING STICKER - Ø3/4" COLLANT DE FINITION - Ø3/4"	5
R		FINISHING STICKER - Ø1/2" COLLANT DE FINITION - Ø1/2"	1
S		GLUE COLLE	1
T		METAL BRACKET - 1/2" X 1/2" SUPPORT DE MÉTAL - 1/2" X 1/2"	2



OUTIL DE VÉRIFICATION DE DIMENSIONS DES PIÈCES  
HARDWARE DIMENSIONS VERIFICATION TOOL





ÉTAPE / STEP 1

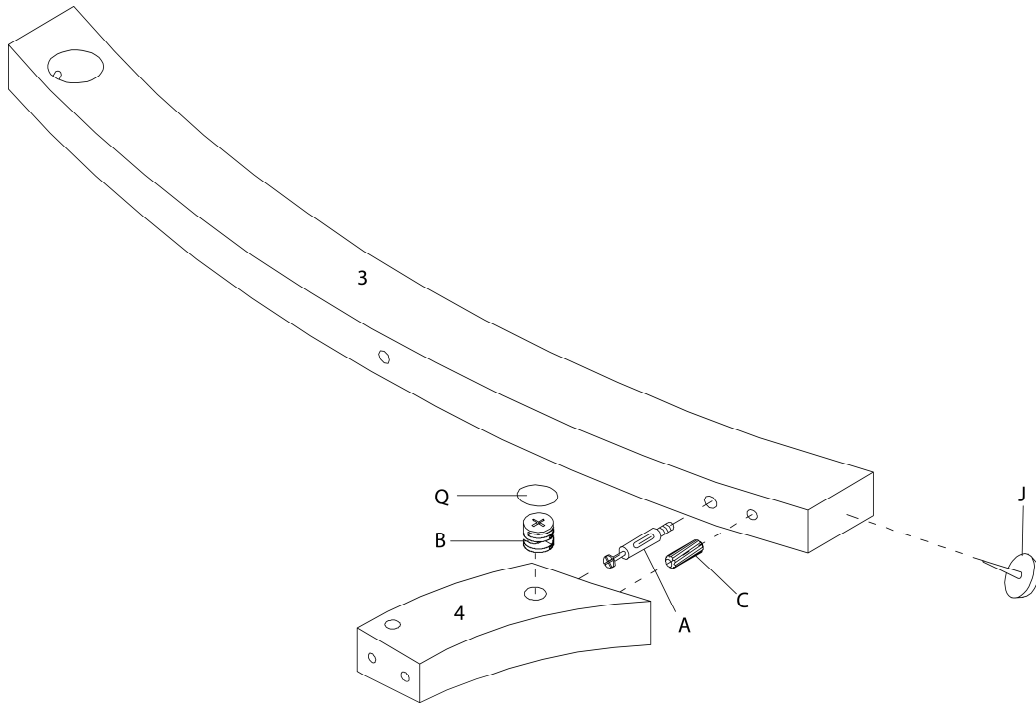

ÉTAPE / STEP 2

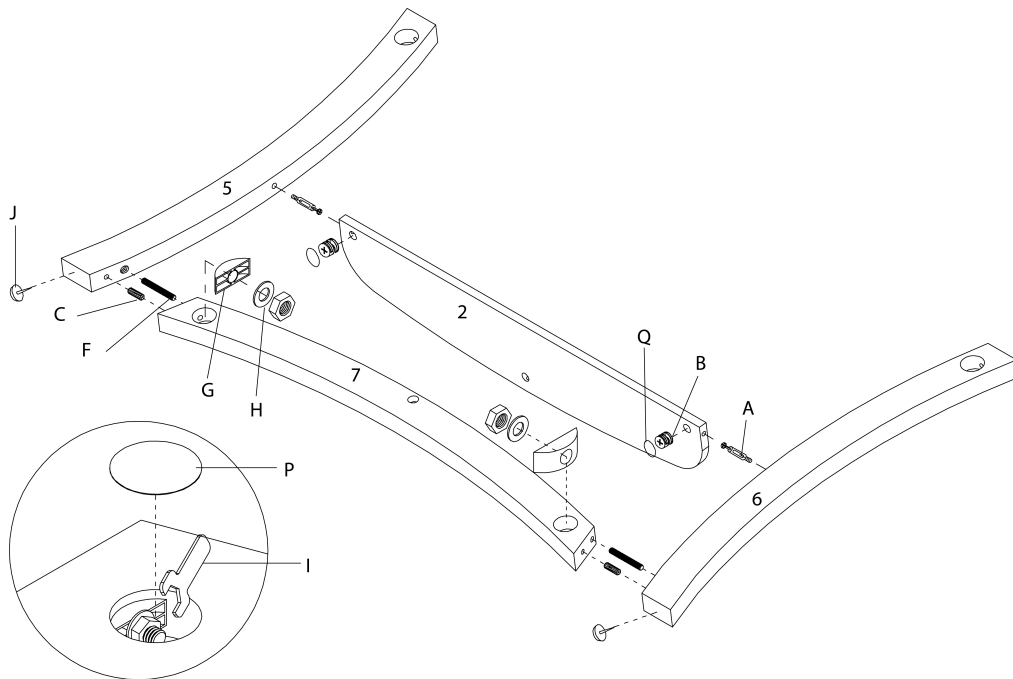

ÉTAPE / STEP 3

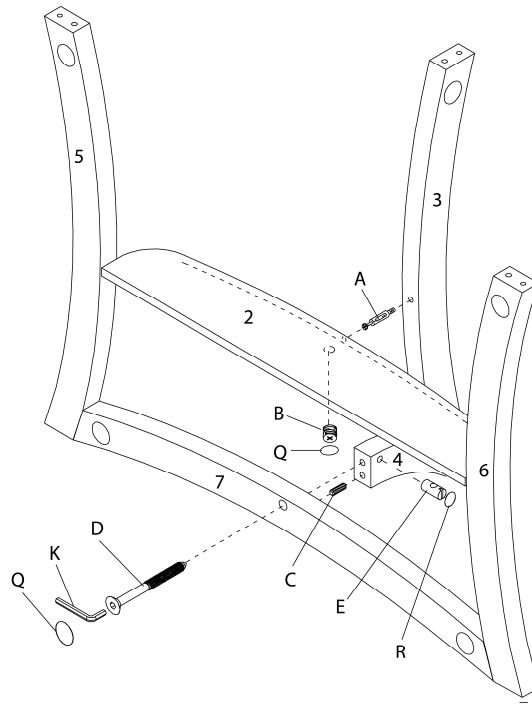

ÉTAPE / STEP 4

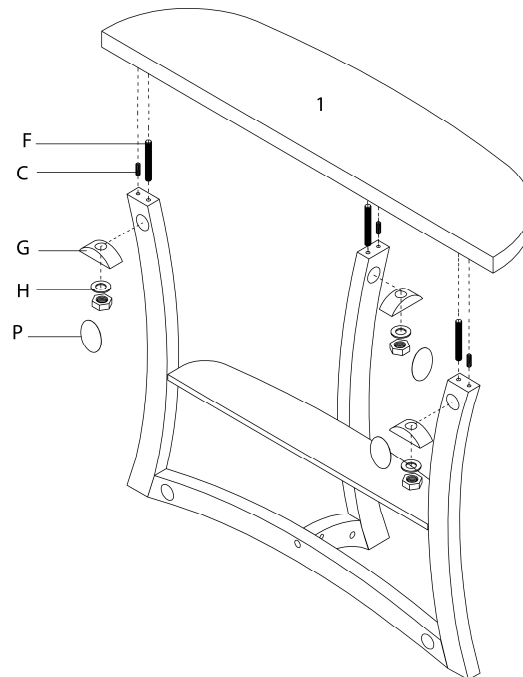

ÉTAPE / STEP 5

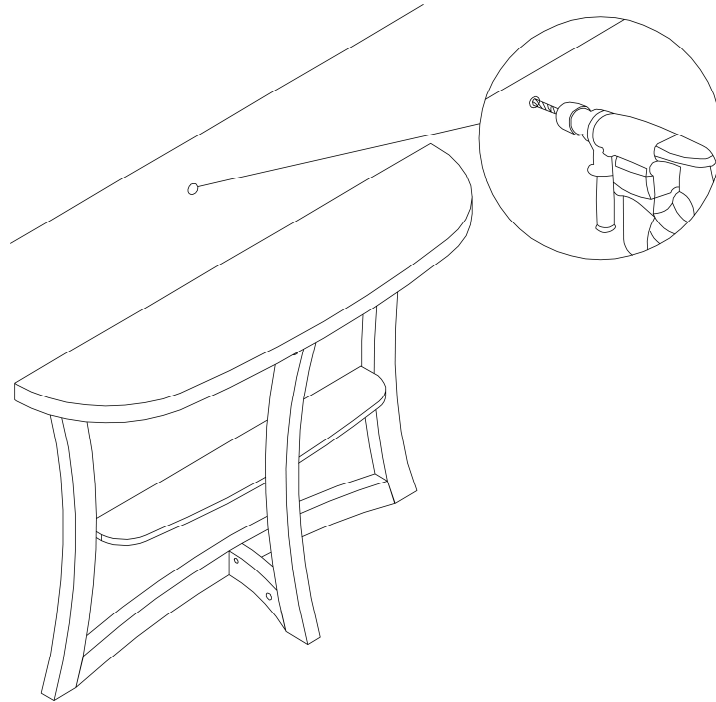

ÉTAPE / STEP 6

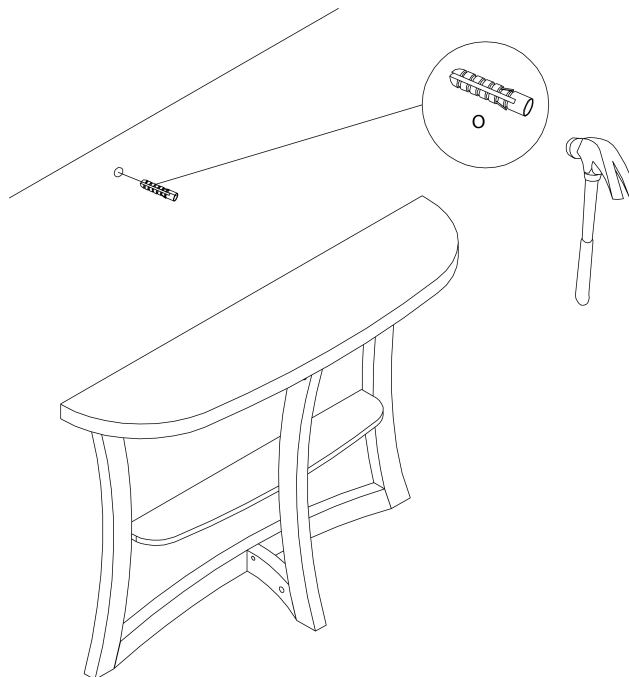

ÉTAPE / STEP 7

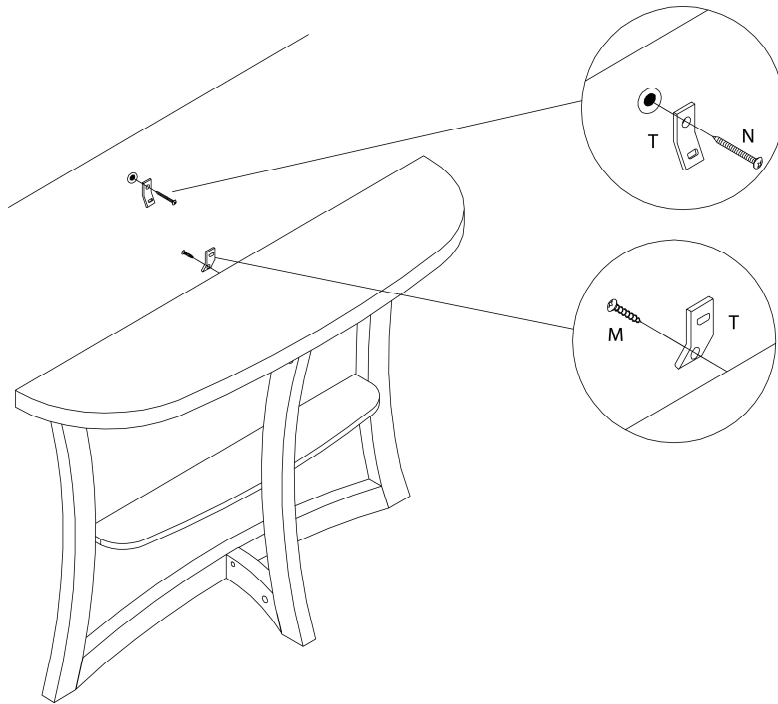

ÉTAPE / STEP 8

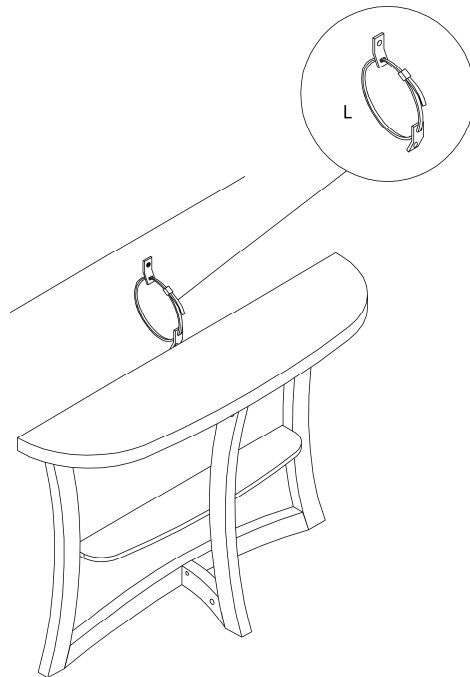

ÉTAPE / STEP 9

