



**INSTRUCTIONS D'ASSEMBLAGE**  
**ASSEMBLY INSTRUCTIONS**

---

**M**ONARCH  
SPECIALTIES INC.

# I 3444

---

**TABLE DE SALON -**  
**44"L / METAL OR AVEC VERRE TREMPÉ**

**COFFEE TABLE -**  
**44"L / GOLD METAL WITH TEMPERED GLASS**



**POUR DE L'ASSISTANCE OU POUR COMMANDER  
DES PIÈCES CONTACTEZ NOTRE DÉPARTEMENT  
DE SERVICE À LA CLIENTÈLE.**

**FOR ASSISTANCE OR TO ORDER PARTS  
CONTACT OUR CUSTOMER SERVICE DEPARTMENT**

**WWW.MONARCHSERVICE.COM**

**LISTE DES PIÈCES**  
**PARTS LIST**

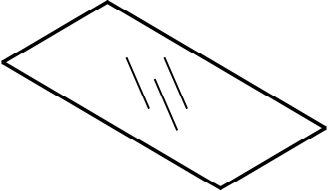
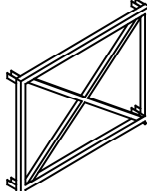
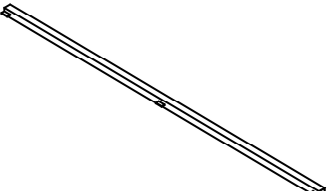
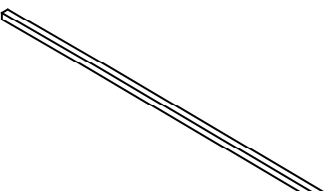
PIÈCE / PART #	IMAGE	DESCRIPTION	QTY / QTÉ
1		<p align="center">GLASS TOP SURFACE EN VERRE</p>	1
2		<p align="center">METAL LEG PATTE EN METAL</p>	2
3		<p align="center">CROSSBAR BARRE TRANSVERSALE</p>	2
4		<p align="center">CROSSBAR BARRE TRANSVERSALE</p>	2

**LISTE DES PIÈCES DE MONTAGE**  
**HARDWARE LIST**

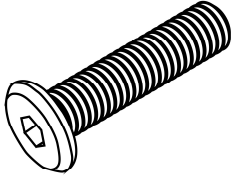
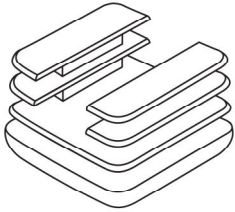
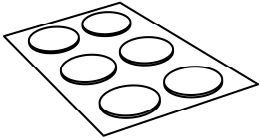
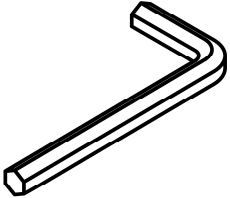
PIÈCE / PART #	IMAGE	DESCRIPTION	QTY / QTÉ
A		<p align="center">ASSEMBLING BOLT - Ø1/4" X 1/2" BOULON D'ASSEMBLAGE - Ø1/4" X 1/2"</p>	16
B		<p align="center">FLOOR PROTECTOR - 3/4" X 3/4" PROTECTEUR DE PLANCHER - 3/4" X 3/4"</p>	4
C		<p align="center">TRANSPARENT RUBBER - Ø3/8" CAOUTCHOUC TRANSPARENT - Ø3/8"</p>	6
D		<p align="center">HEX KEY CLÉ HEXAGONALE</p>	1



OUTIL DE VÉRIFICATION DE DIMENSIONS DES PIÈCES  
HARDWARE DIMENSIONS VERIFICATION TOOL



ÉTAPE / STEP 1

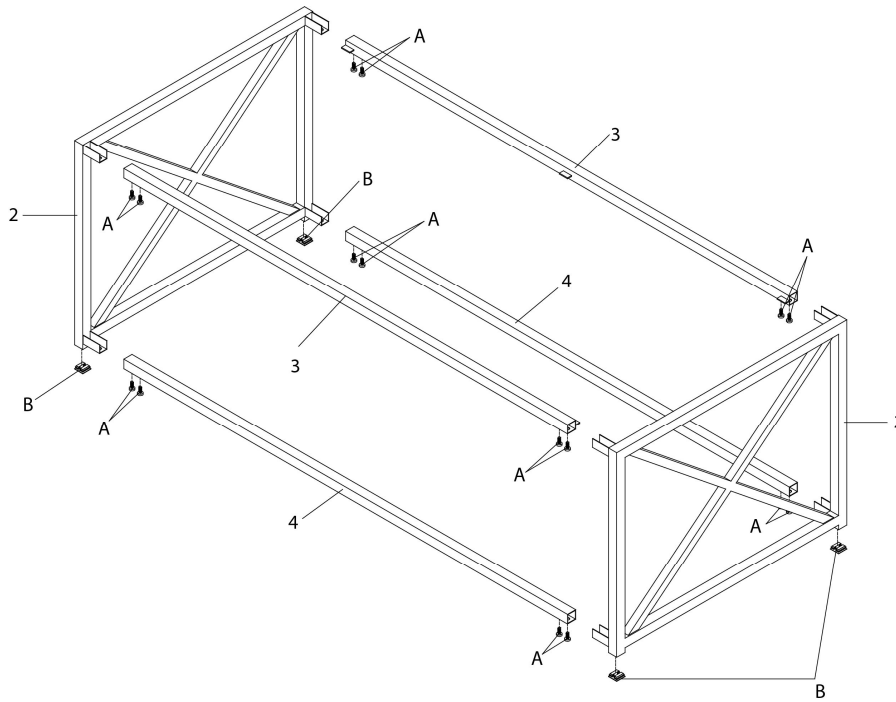

ÉTAPE / STEP 2

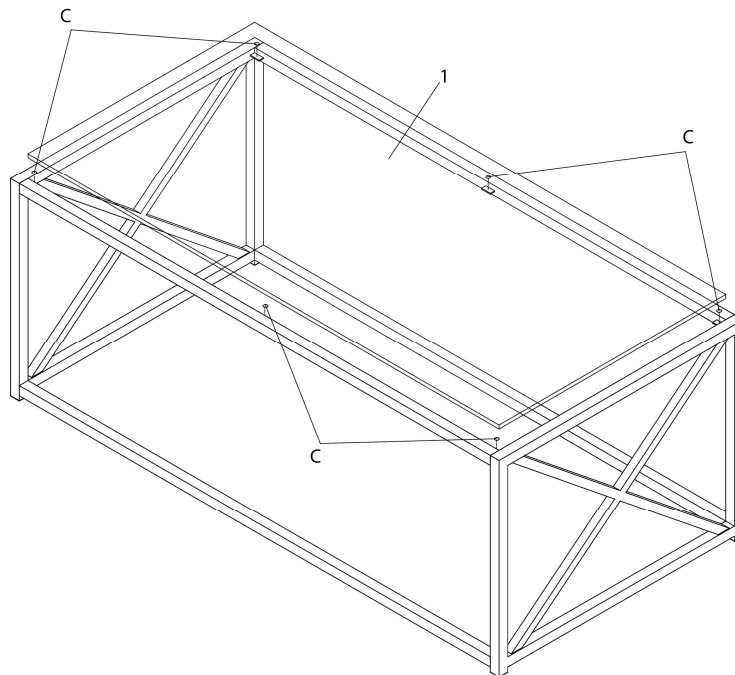

ÉTAPE / STEP 3

