



INSTRUCTIONS D'ASSEMBLAGE
ASSEMBLY INSTRUCTIONS

MONARCH
SPECIALTIES INC.

I 3572

TABLE D'APPOINT -
48" L / CONSOLE D'ENTREE GRIS / NOIR

ACCENT TABLE -
48" L / GREY / BLACK METAL HALL CONSOLE



**POUR DE L'ASSISTANCE OU POUR COMMANDER
DES PIÈCES CONTACTEZ NOTRE DÉPARTEMENT
DE SERVICE À LA CLIENTÈLE.**

**FOR ASSISTANCE OR TO ORDER PARTS
CONTACT OUR CUSTOMER SERVICE DEPARTMENT**

WWW.MONARCHSERVICE.COM

LISTE DES PIÈCES
PARTS LIST

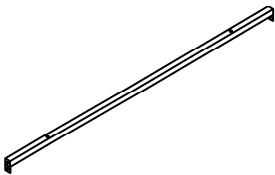
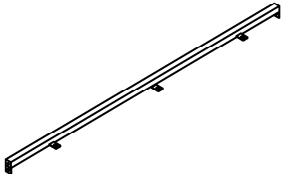
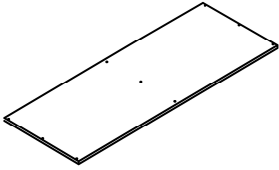
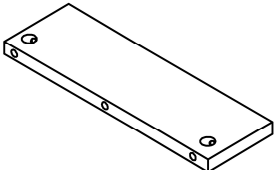
PIÈCE / PART #	IMAGE	DESCRIPTION	QTY / QTÉ
1		<p>SIDE FRAME CADRE DE CÔTÉ</p>	2
2		<p>CROSSBAR (TOP) BARRE TRANSVERSALE (HAUT)</p>	2
3		<p>CROSSBAR (BOTTOM) BARRE TRANSVERSALE (BAS)</p>	2
4		<p>TABLE TOP SURFACE DE TABLE</p>	1
5		<p>SUPPORT PANEL PANNEAU DE SOUTIENT</p>	3

LISTE DES PIÈCES
PARTS LIST

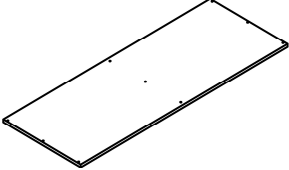
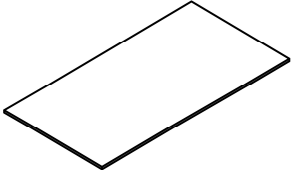
PIÈCE / PART #	IMAGE	DESCRIPTION	QTY / QTÉ
6		BOTTOM PANEL PANNEAU DU BAS	1
7		SHELF ÉTAGÈRE	1

LISTE DES PIÈCES DE MONTAGE
HARDWARE LIST

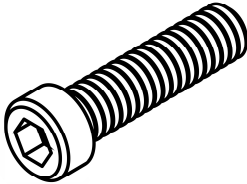
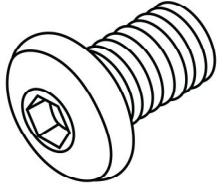
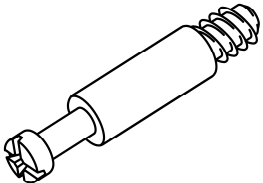
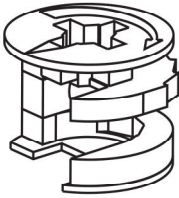
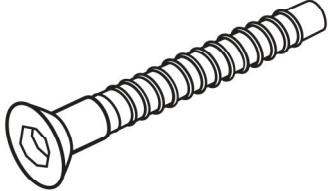
PIÈCE / PART #	IMAGE	DESCRIPTION	QTY / QTÉ
A		ASSEMBLING BOLT - Ø 1/4" X 1 1/4" BOULON D'ASSEMBLAGE - Ø 1/4" X 1 1/4"	12
B		ASSEMBLING BOLT - Ø 1/4" X 3/8" BOULON D'ASSEMBLAGE - Ø 1/4" X 3/8"	12
C		CAM LOCK SCREW VIS CAM LOCK	6
D		CAM LOCK CONNECTOR ÉCROU CAM LOCK	6
E		ASSEMBLING BOLT - Ø 1/4" X 1 5/8" BOULON D'ASSEMBLAGE - Ø 1/4" X 1 5/8"	6

LISTE DES PIÈCES DE MONTAGE
HARDWARE LIST

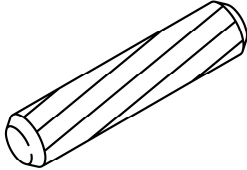
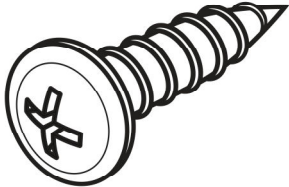
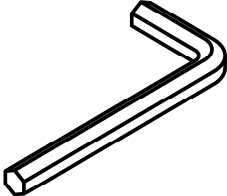
PIÈCE / PART #	IMAGE	DESCRIPTION	QTY / QTÉ
F		<p>WOOD DOWEL GOUJON DE BOIS</p>	6
G		<p>ASSEMBLING SCREW - Ø 1/2" VIS D'ASSEMBLAGE - Ø 1/2"</p>	2
H		<p>HEX KEY CLÉ HEXAGONALE</p>	1

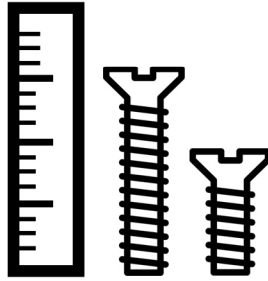

OUTIL DE VÉRIFICATION DE DIMENSIONS DES PIÈCES
HARDWARE DIMENSIONS VERIFICATION TOOL

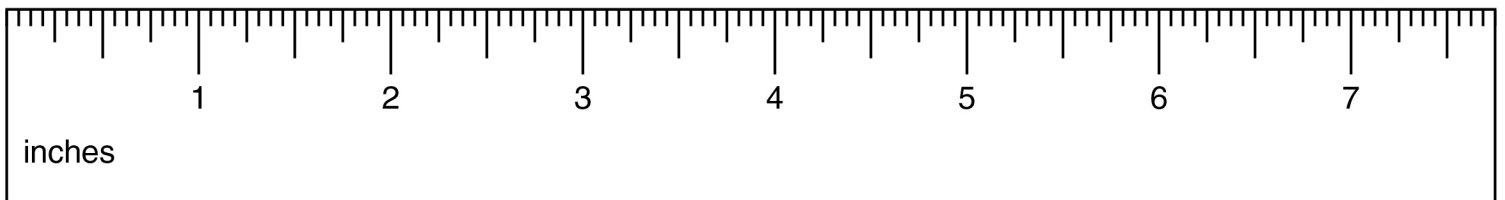

ÉTAPE / STEP 1

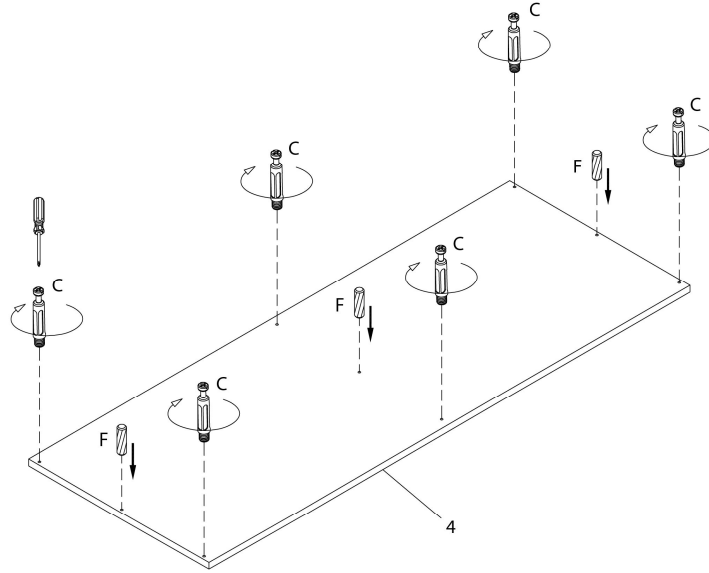

ÉTAPE / STEP 2

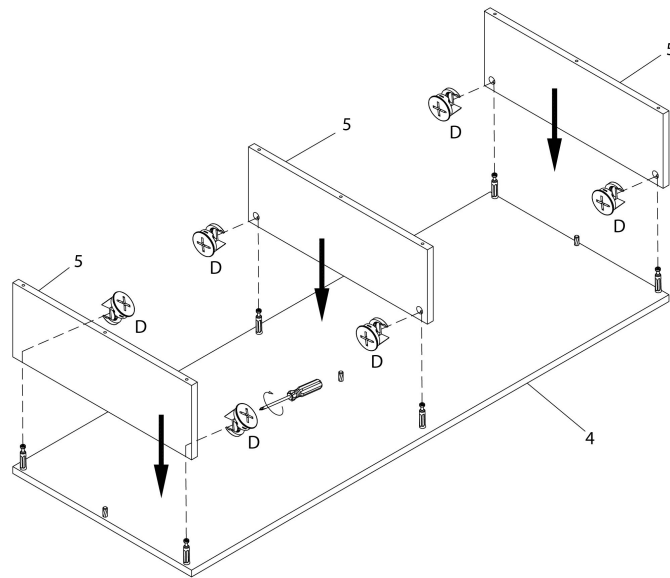

ÉTAPE / STEP 3

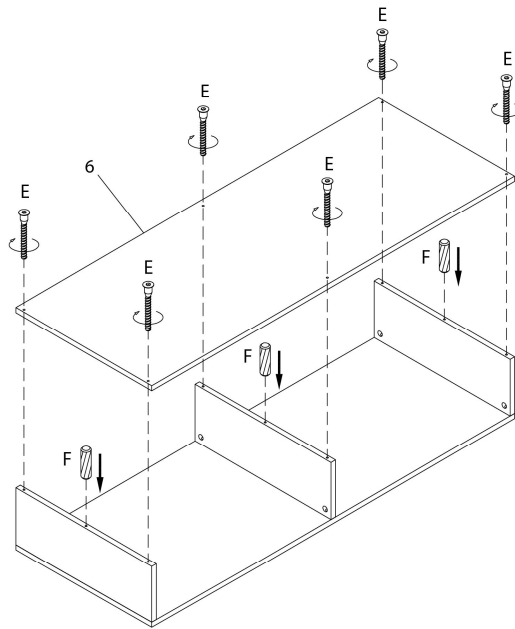

ÉTAPE / STEP 4

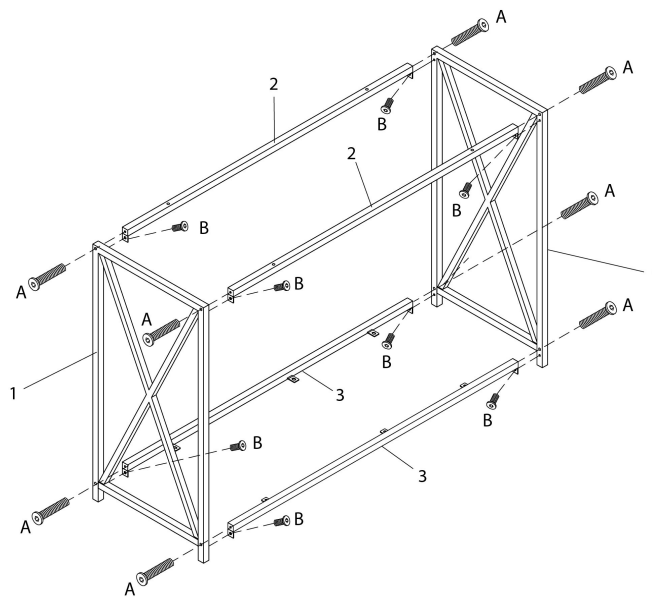

ÉTAPE / STEP 5

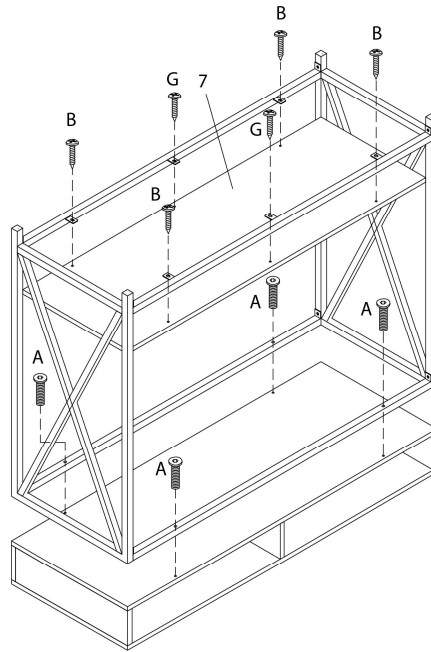

ÉTAPE / STEP 6

