



**INSTRUCTIONS D'ASSEMBLAGE  
ASSEMBLY INSTRUCTIONS**

---

**M**ONARCH  
SPECIALTIES INC.

**I 9757**

---

**LUMINAIRE -  
62"H LAMPE SUR PIED TREPIED NICKEL  
METAL/GRIS**

**LIGHTING -  
62"H TRIPOD FLOOR LAMP NICKEL METAL / GREY**





**POUR DE L'ASSISTANCE OU POUR COMMANDER  
DES PIÈCES CONTACTEZ NOTRE DÉPARTEMENT  
DE SERVICE À LA CLIENTÈLE.**

**FOR ASSISTANCE OR TO ORDER PARTS  
CONTACT OUR CUSTOMER SERVICE DEPARTMENT**

**WWW.MONARCHSERVICE.COM**

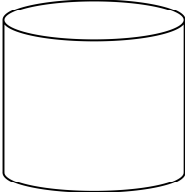
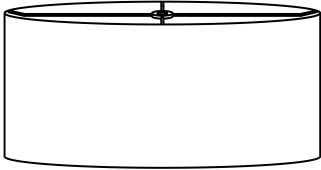
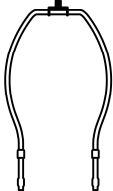
**LISTE DES PIÈCES**  
**PARTS LIST**

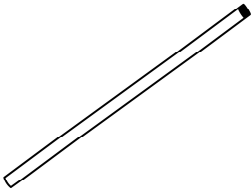
PIÈCE / PART #	IMAGE	DESCRIPTION	QTY / QTÉ
1		<p>FINIAL FAÎTEAU</p>	1
2		<p>SHADE ABAT-JOUR</p>	1
3		<p>HARP LYRE</p>	1
4		<p>LAMP BASE SOCLE DE LAMPE</p>	1
5		<p>LAMP BASE SOCLE DE LAMPE</p>	4

**LISTE DES PIÈCES**  
**PARTS LIST**

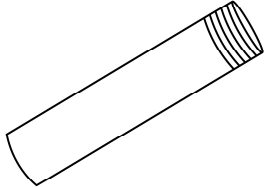
PIÈCE / PART #	IMAGE	DESCRIPTION	QTY / QTÉ
6		LAMP BASE SOCLE DE LAMPE	3

ÉTAPE / STEP 1

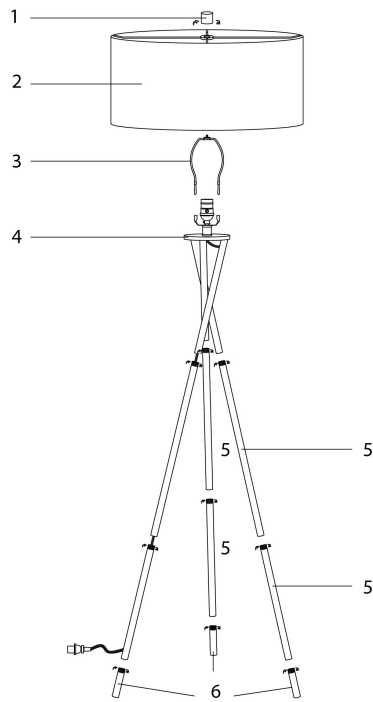

ÉTAPE / STEP 2

